

Xtend Pro

SD/Micro SD Duplicator

User's manual

CONTENT

- I. INTRODUCTION..... 5**
 - 1. FEATURES 5
 - 2. CONTROL PANEL OVERVIEW 6
 - 3. TECHNICAL SPECIFICATION 7

- II. WARNING 7**

- III. SYNCHRONOUS / ASYNCHRONOUS MODE 8**
 - 1. SYNCHRONOUS MODE (DEFAULT) 8
 - 2. ASYNCHRONOUS MODE 8

- IV. MENU OVERVIEW 9**
 - 1. COPY 9
 - 2. COMPARE 10
 - 3. COPY + COMPARE 10
 - 4. DUAL SOURCE COPY + COMPARE 10
 - 5. FORMAT + CAPACITY CHECK 11
 - 6. UTILITY 12
 - 6.1 Measure Speed 12
 - 6.2 Quick Erase 12
 - 6.3 Full Erase 12
 - 6.4 Media Information 13
 - 6.5 System Information 13
 - 6.6 System Update 14
 - 7. SETUP 14
 - 7.1 Copy Area 14
 - 7.2 ASYNCHRONOUS MODE 15
 - 7.3 Set Type of Format 16
 - 7.4 Set Capacity Threshold 16
 - 7.5 Set Slow Out Threshold 17
 - 7.6 Performance 17
 - 7.7 Button Beep 18

7.8 Boot Password.....	18
7.9 Lock Menu.....	19
7.10 Language.....	19
7.11 Clear Setup.....	20
V. BASIC TROUBLESHOOTING	20

ULTRA THIN AND LIGHT WEIGHT



I. INTRODUCTION

Xtend Pro is a 23-target commercial grade SD/Micro SD duplicator which only takes up to 1/10 of a regular duplicator space. It has higher output capacity and powerful functionalities by bundle with special designed user menu selections, such as Dual Source Copy + Compare, Format + Capacity Check, and Set Slow Out Threshold. The compact and light weight Xtend Pro SD/Micro SD duplicator is ideal for workplaces with space limitation, like small office and retail store. With expandable design, Xtend Pro can be daisy chained together up to ten units to provide 239 ports for duplication, which is 10 times output capacity than a single unit making your daily job easier and flexible even with huge quantity duplication demand.

Xtend Pro is designed and developed based on the FPGA from the world famous semiconductor company XILINX. Every processing channel is parallel to each other with its own control unit, therefore the duplicator will not sacrifice speed for the increasing number of targets loaded - always remain the same and fast copy speed. The duplicator supports fast copy with multiple file formats created by three major operating systems (Windows/Linux/Mac OS X), and makes mirror copies of data efficiently. Furthermore, this duplicator has been fully tested with quality assurance before leaving our manufacturing facility.

1. FEATURES

- Each processing channel has its own control unit and operates independently with dedicated bandwidth of up to 25MB per second.
- Standalone operation. No PC or software is required, minimizing possible computer virus infection.
- Instant power on and off, no warm-up or cool-down required.
- Easy to use One-Touch operation.
- Compare function available for verification of copy accuracy. The newly added Dual Source Copy + Compare function can further compare the copied media with second source to make sure the copy accuracy against unexpected damage to the source

media.

- Menu options are user-friendly and easily accessed through the 4-button control panel. Use ▲ or ▼ button to scroll through the options and view the operation status of each channel on the 2-line backlit LCD display.
- Support Synchronous and Asynchronous copy modes for best operation efficiency.
- Powerful 32-bit CRC checksum to assure data integrity.
- Heavy-duty hardware construction for commercial production and personal use.
- External power adapter with full range of voltage (100V-240V) input makes it possible to duplicate anywhere around the world.
- Designed to save time and effort in creating multiple copies quickly and reliably, Xtend Pro can be daisy chained together to provide up to 239 ports for duplication
- Unique source data analysis to copy data area only to achieve highest efficiency
- Supports multiple file formats: Windows: FAT 16/32、 exFAT、 NTFS, Linux: Ext 2/3/4, Mac OS X: HFS/HFS+
- Eliminating the media with slow read/write speed to expedite the process for the rest of media in the same batch.

2. CONTROL PANEL OVERVIEW

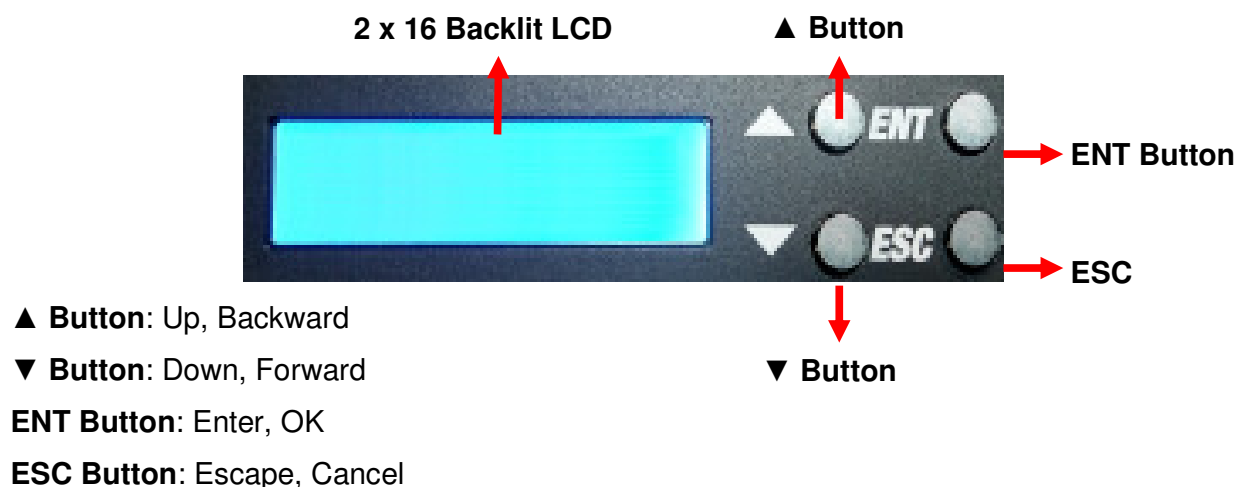

3. TECHNICAL SPECIFICATION

Operation Type	Standalone (No PC or Software is required)
Target	23 targets (22 targets with Dual Source Copy + Compare); Up to 239 targets with Daisy Chain
Copy Speed	25MB/sec
Copy Mode	Synchronous/Asynchronous
Copy Area	Whole Media/File and System(Fast Copy)
Supported Media	SD or Micro SD card depending on models (format: SD/SDHC/SDXC)
Supported File System Format (for Fast Copy)	Windows: FAT16,FAT32,exFAT,NTFS Linux: Ext2,Ext3,Ext4 Mac OS X: HFS/HFS+
Display	2 x 16 Backlit LCD
Operation Interface	4 control buttons (▲ / ▼ / ENT / ESC)
Memory	128MB
Power Adaptor	Input : AC 100-240V; Output : DC 12V/3A
Certificate	FCC, CE, UL
Size	18.5cm(L) x 14.5cm(W) x 4.2cm(H)
Weight	0.8Kg

II. WARNING

1. The duplicator tasks mentioned in this user's manual are as following: Copy, Compare, Copy + Compare, Dual Source Copy + Compare, Format + Capacity Check, and the functions under Utility sub menu, such as Measure Speed, Quick Erase, Full Erase and Media Information.
2. All the tasks can be executed in synchronous mode, and asynchronous mode (**except Copy + Compare function and Dual Source Copy + Compare**).
3. The Green LED flashes during the execution process of a task. After the task is done, the Green LED will stay solid if the process is successful, otherwise the Red LED will be on if the process is failed.
4. Press and hold ESC button during the execution process of a task will stop and exit the execution of the task.
5. DO NOT unplug SD or Micro SD card from the duplicator during the execution process of a task. It may cause damage to the duplicator system and media.

6. It is strongly recommended that the capacities of the source and target media are equal or similar.
7. DO NOT plug in SD or Micro SD card until the duplicator boots up. It may cause abnormal results if a SD or Micro SD card with quality issue is plugged in before or during the boot up process.

III. SYNCHRONOUS /ASYNCHRONOUS MODE

1. SYNCHRONOUS MODE (DEFAULT)

Synchronous Mode means that the duplicator will start to execute a task after the source and target devices have been inserted and the ENT button is pressed. The task will begin and end at the same time for all target devices. Any other target device plugged in during the process of a task will not be executed with the task.

- a. Insert source device into the source channel and blank devices into the target channels properly. The LCD display will show no source disk when source device is not plugged in yet, and show the number of target devices inserted when source device plugged in.
- b. The green LED will be on if the target device is plugged in properly.
- c. Select the task from menu, and press ENT button to execute it.
- d. During the execution process, the status of each target device can be checked by using the ▲ and ▼ buttons.
- e. After the task is done, LCD display will show the number of successful and failed target(s).

2. ASYNCHRONOUS MODE

Asynchronous Mode means that the duplicator will read the data from source device into system memory buffer and start to execute a task immediately when target device(s) inserted. Duplicator does not have to wait for all target device(s) to be inserted in order to start the execution of the task at the same time. No matter the data size of the source device, duplicator can asynchronously execute a task if Asynchronous Mode is enabled.

- a. Insert source device into the source channel, select the task to execute from the menu, and press ENT button. Duplicator will start to execute the task now.
- b. Target devices can be plugged in during the execution process, and will start to execute

- the task immediately.
- c. Target device can be removed when it finishes the execution process and its green LED is solid on. New target device can be plugged into the same channel for execution of the task again.
 - d. LCD display will show the percentage of execution process, the number of successful and failed target(s). Here the percentage of execution process displayed is only for the least processed target device.
 - e. During the execution process, the status of each target device can be checked by using the ▲ and ▼ buttons.
 - f. After the task is done for all target devices, press ESC button to exit from the task. LCD display will show the total number of successful and failed target(s).
 - g. Don't need to wait for all target devices to be done. Each channel executes the task asynchronously.

IV. MENU OVERVIEW

1. COPY

To copy from source device to target device(s), please go to **7.1 Copy Area** to select the setting first before this step.

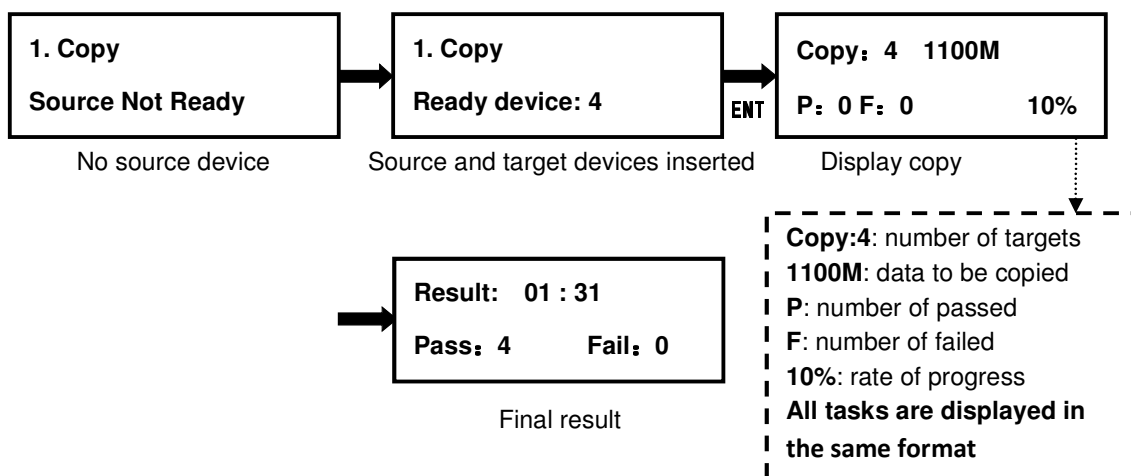

2. COMPARE

This command allows to compare the copied target devices against the source for accuracy.

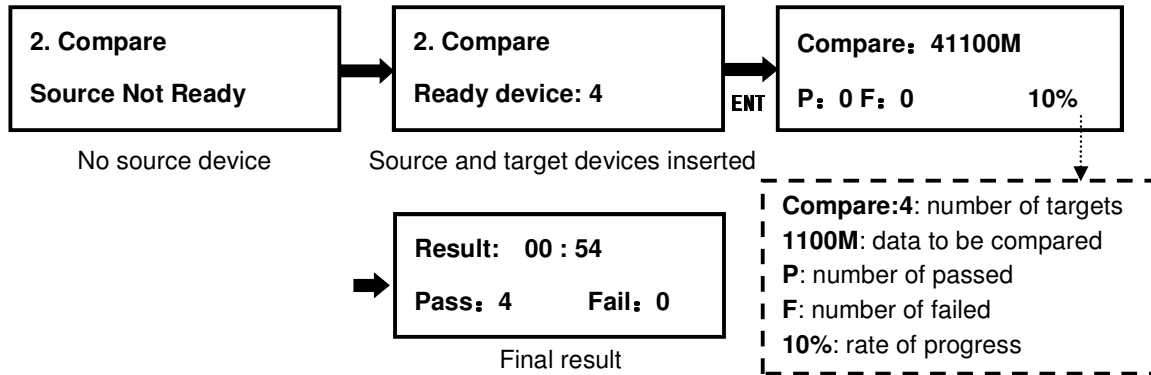

3. COPY + COMPARE

This command allows duplicator to start Copy process first, then follow with Compare process immediately.

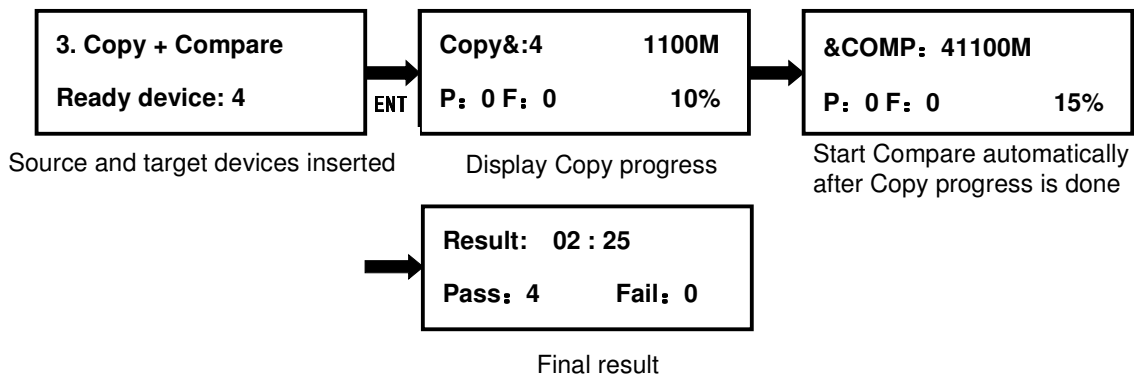

4. DUAL SOURCE COPY + COMPARE

Two source devices with identical content will be used for this task. One source device is inserted into source port while the other inserted into the 1st target port. Duplicator starts copy process first and reads data content from the source port; duplicator then starts compare process after copy is done, and reads data content from the 1st target port. By comparing the copied devices against the second source, it can find out if the source device has unexpected damage or not, and avoid the waste of time and media for further

duplication. The rest of procedure is the same as regular Copy + Compare procedure.

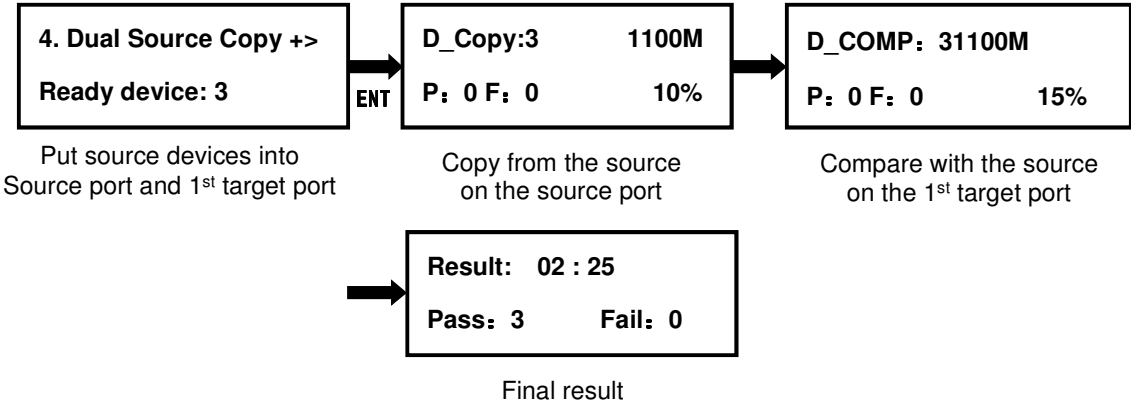

5. FORMAT + CAPACITY CHECK

It will format the target devices to the file format according to the system Setup (please refer to 7.3Set Type of Format), then sort out target devices based on the capacity threshold (please refer to 7.4Set Capacity Threshold). Duplicator will display the target device which is not in the capacity range and its red LED will flash. Press ▲ ▼ button to switch between the target devices with smaller capacity to check the data status. The ones without capacity issue will not be displayed to expedite the capacity check process. If Format and or Capacity Check is failed, the red LED will stay solid on.

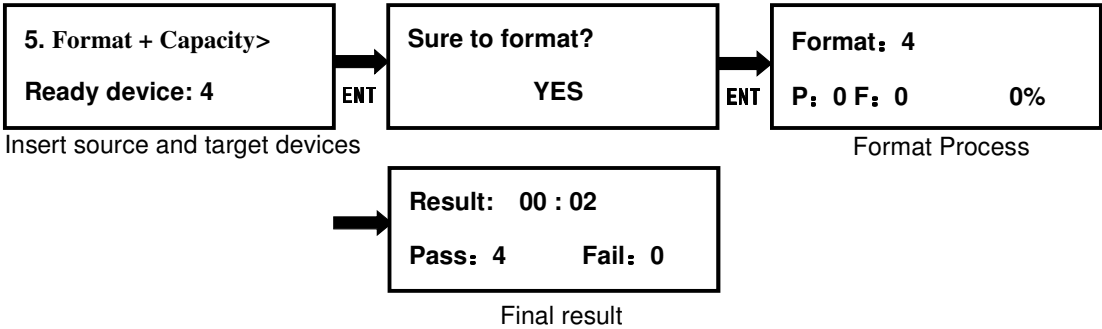

6. UTILITY

6.1 Measure Speed

This function allows to measure the actual Read and Write speed of all devices. It will NOT alter or erase existing data on the target devices.

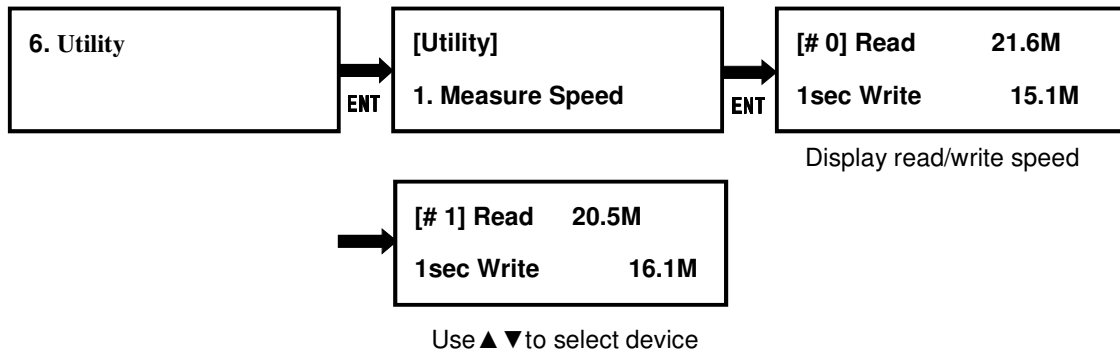

6.2 Quick Erase

This function erases the table content of file system of the target devices, so it is fast to do Quick Erase. There is chance that some files can be retrieved by software.

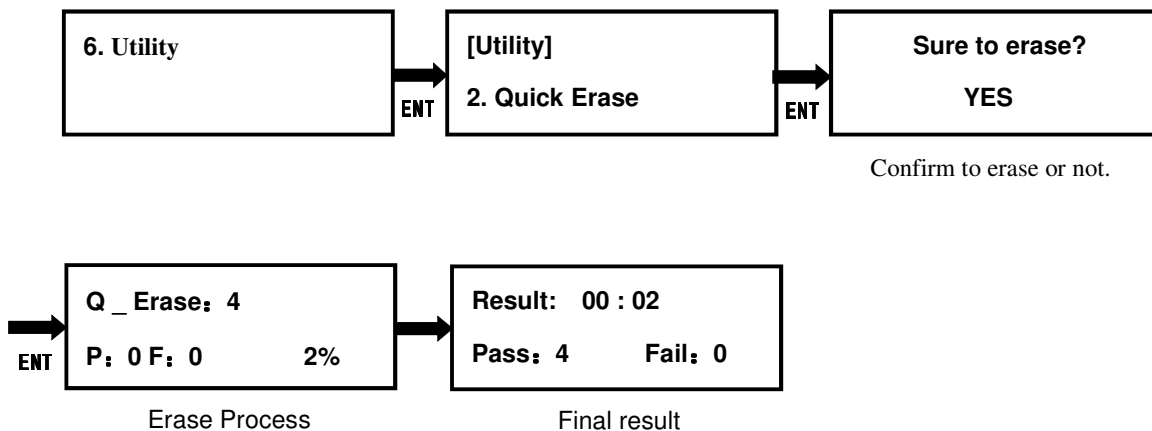

6.3 Full Erase

This function completely erases the content of target devices. It takes longer time to erase and the content will not be retrieved by software.

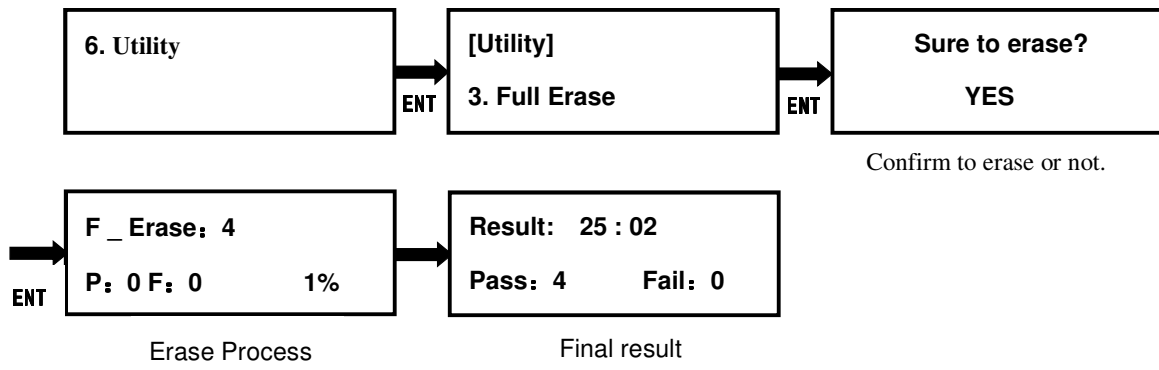

6.4 Media Information

This function displays the information of selected device media, such as total capacity, file format and the size of data content.

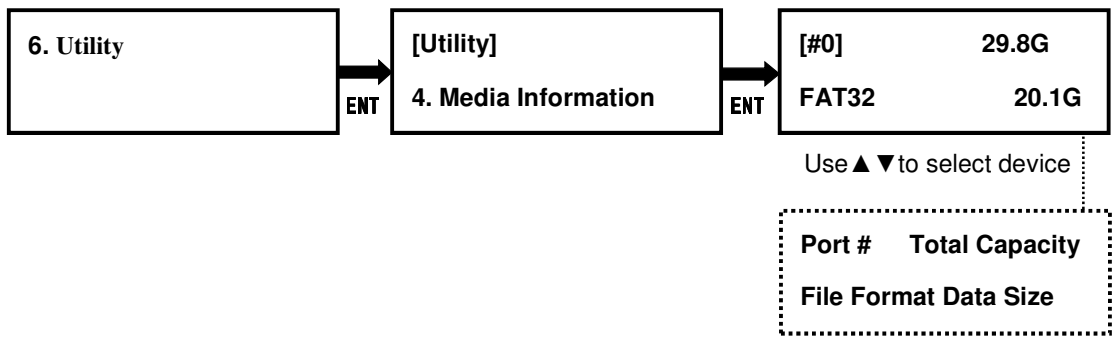

6.5 System Information

This function displays general information of the duplicator system, including controller model, system memory size, and firmware version.

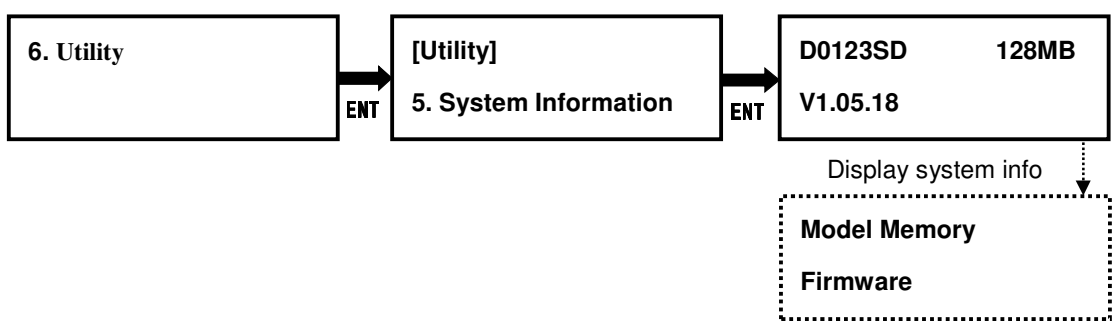

6.6 System Update

This function allows user to update the firmware of duplicator when necessary. Please obtain the proper firmware file from manufacturer, and save the unzipped file under home folder on the SD or Micro SD card (DO NOT save the file under sub folder). Insert the SD or Micro SD card containing the firmware into the source port of duplicator and press ENT. It will update the system, reboot the duplicator after update, active and operate the system under the new firmware.

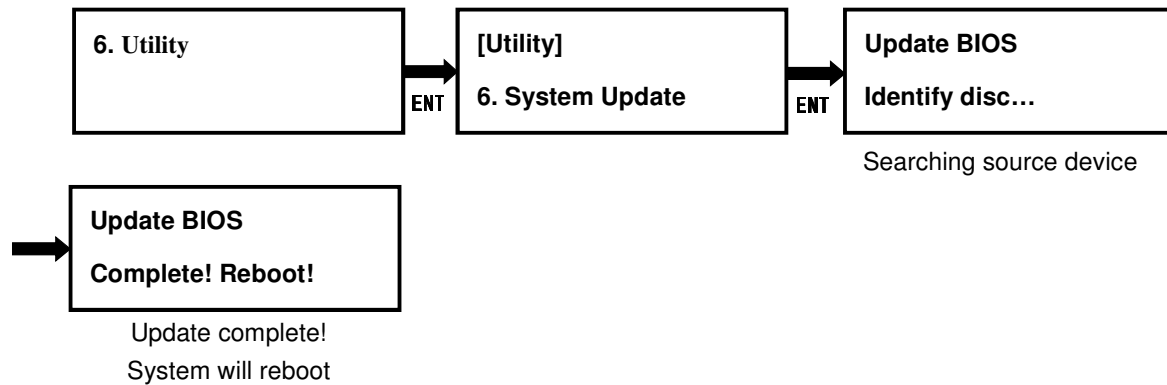

7. SETUP

7.1 Copy Area

This function allows to select the area on the source device to copy onto the target devices. You may select “System and Files” to skip all the unoccupied area on the source device or “Whole Media”. By default, the copy area is set up as **System and Files**.

System and Files:

The duplicator first analyzes the file format of source device. You may copy only the system and file area to save overall copy time if the file format is FAT16, FAT32, exFAT, NTFS (Windows), EXT2, EXT3, EXT4 (Linux), and HFS/HFS+ (Mac). Otherwise, the duplicator will copy the entire source device content to the target devices including unoccupied space. For instance, the source device has 8GB capacity but with only 50MB of data in FAT32 file

format. The duplicator will copy only the 50MB of data area to the target device, hence shortening overall copy time.

Whole Media:

When selected, the duplicator copies the entire content on the source device, including both the data and empty spaces. This option is used when you have a source device with unknown file format. For instance a source device has 8GB capacity and 50MB of data with unknown file format, the duplicator will copy the whole 8GB of content to target devices.

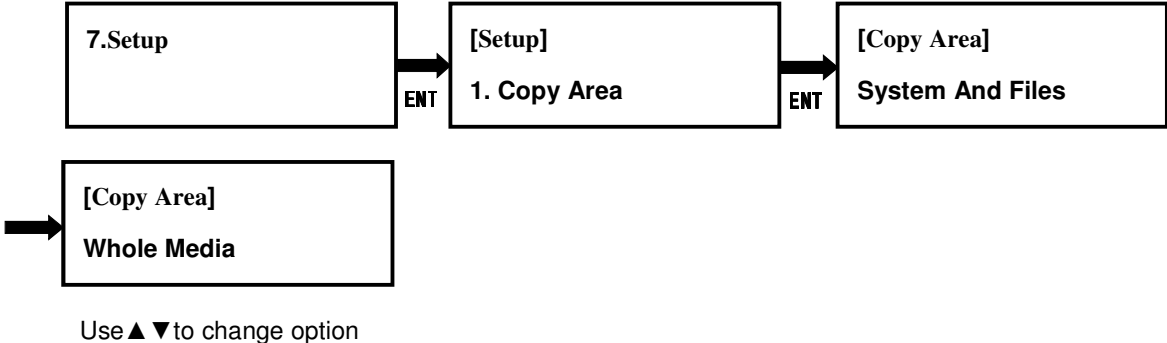

7.2 Asynchronous Mode

This function enables or disables Asynchronous Mode. By default the Asynchronous Mode is disabled. Please refer to Chapter III for the detail of operation on Synchronous and Asynchronous Mode.

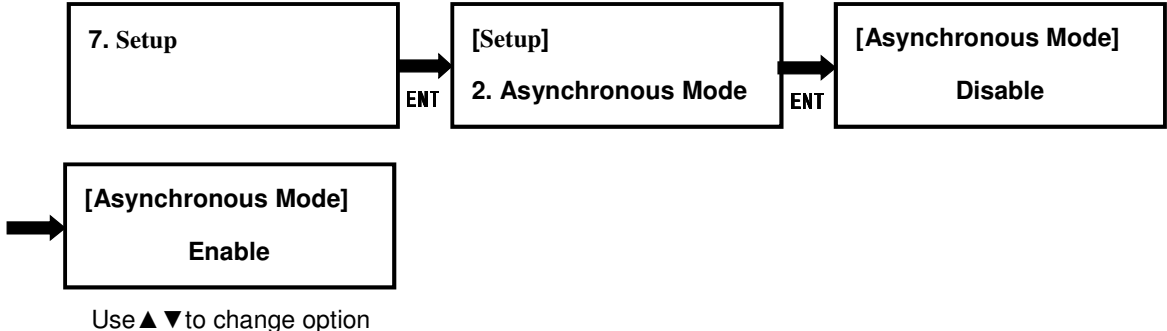

7.3 Set Type of Format

This function allows to set up the target device format, and the setting will be applied by Command 5. Format + Capacity Check under the main menu. The options are FAT32, exFAT, and Depends On Size. The default setting is Depends On Size.

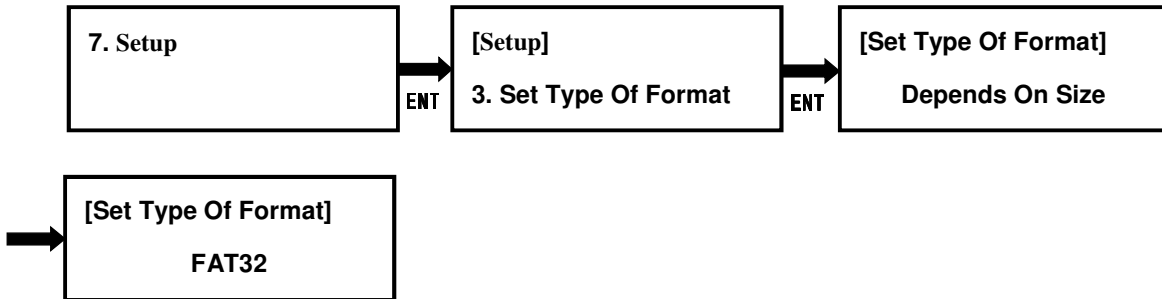

7.4 Set Capacity Threshold

This function allows to set up the capacity threshold for Command 5. Format + Capacity Check under main menu. It will be failed when the target device capacity is below the threshold range, and the red LED will flash to give warning. There are 3 settings.

Capacity: the size of device capacity which will be used for sorting, and options are OFF, 128M, 256M, 512M, 1G, 2G, 4G, 8G, 16G, 32G, 64G, 128G, 256G, 512G, 1T, 2T. The default is OFF.

Tolerance: the acceptable range of capacity for sorting, and options are OFF, 0~50%. The default setting is 5%.

Capacity Definition: define the standard for capacity conversion. Options are 1MB=1000K and 1MB=1024K. The default is 1MB=1000K.

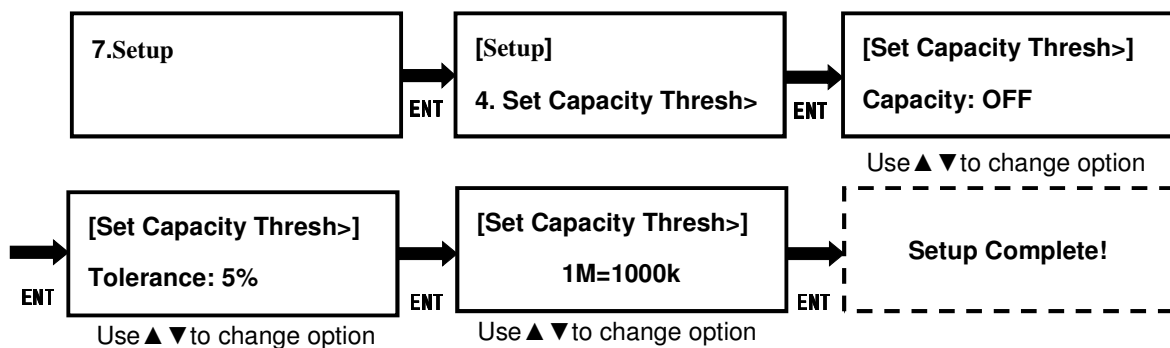

7.5 Set Slow Out Threshold

This function allows to set up read/write speed threshold for target devices. When the target device is causing the copy or compare process delay due to its lower read/write speed and the rest of the devices in the same batch have to wait for it, the Slow Out Threshold strategy will be applied as the following: the system will stop the copy or compare process for that particular target device when its read/write speed is below the threshold for continuing number of seconds based on the setting, and its red LED will flash to give warning. There are 3 settings to set up.

Read: set up the lowest read speed, and options are OFF, 1MB/s~25MB/s. The default setting is OFF.

Write: set up the lowest write speed, and options are OFF, 1MB/s~25MB/s. The default setting is OFF.

Duration: set up the period when read or write speed is lower than the threshold for continuing number of time, and options are 1~20second. The default is 5second.

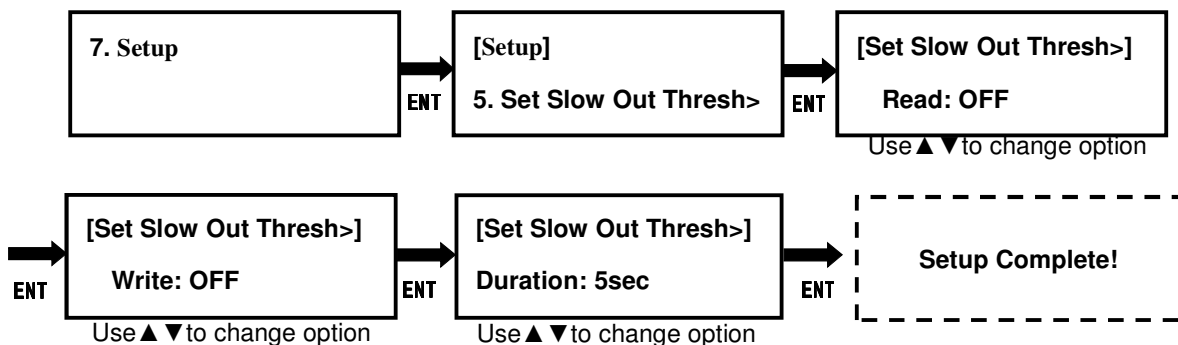

7.6 Performance

This function allows to set up the performance for Copy function based on the following modes: **Speed**, **Balance**, and **Compatibility**.

Speed mode is to execute the Copy function at the fastest speed, but may have compatibility issue with certain brands flash media.

Balance mode is to execute the Copy function at stable speed, and have less compatibility issue with certain brands flash media.

Compatibility mode is to execute the Copy function at the most stable speed, and almost have no compatible issue with flash media. The default mode is Speed.

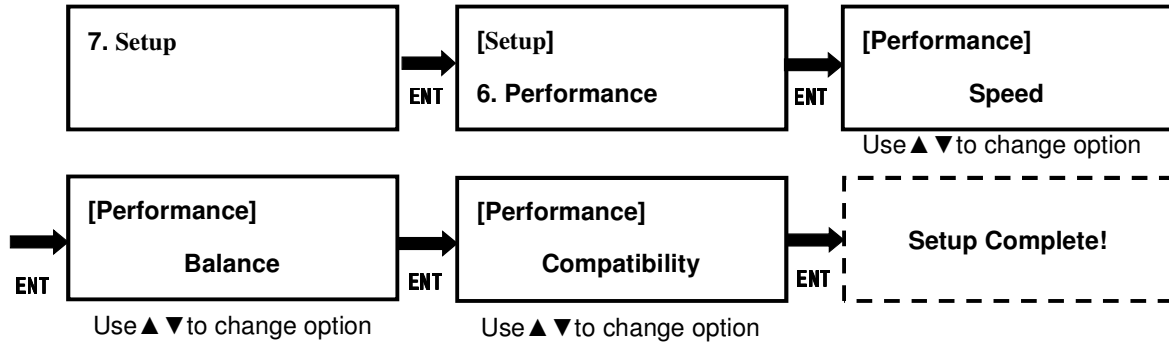

7.7 Button Beep

This function allows to set up button sound from the following options: **Button & Warning**, **OFF**, **Warning only**. The default setting is Button & Warning.

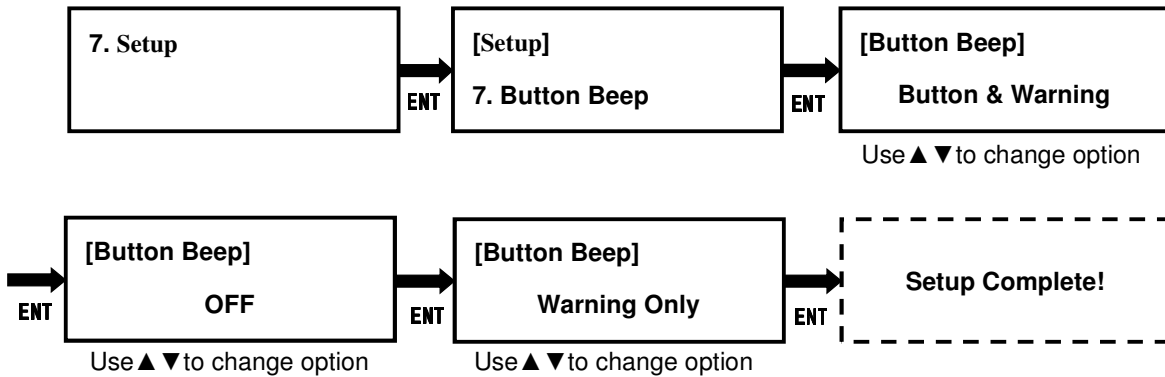

7.8 Boot Password

This function allows to set up password for system boot up to prevent the duplicator from unauthorized use. The password must be 6 characters long. This function only works with single unit operation, but not multiple units with daisy chain.

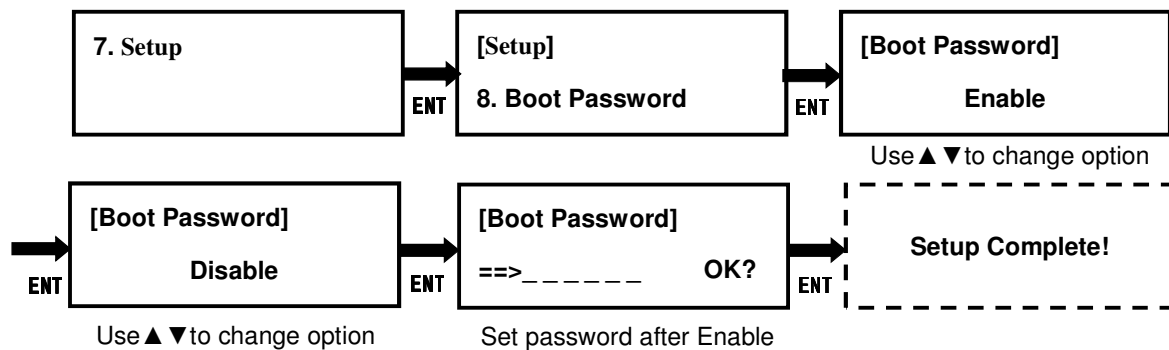

7.9 Lock Menu

This function allows to set up password to lock Main Menu. Press and hold ESC button for 5 seconds under Main Menu, a screen for password input will pop up. After key in password, the system will be locked at the current Main Menu. Repeat the same procedure of locking Main Menu to unlock the Main Menu if necessary. If no password is keyed in, the system will skip password input, and continue to lock/unlock Main Menu. **The number on the Main Menu will become # sign when it is locked, reminding it is under locked mode.** This function only works with single unit operation, but not multiple units with daisy chain. It is to prevent the duplicator from operational mistake by accident when main menu function is processed, therefore sub menu function and system setup will not support the Lock Menu function.

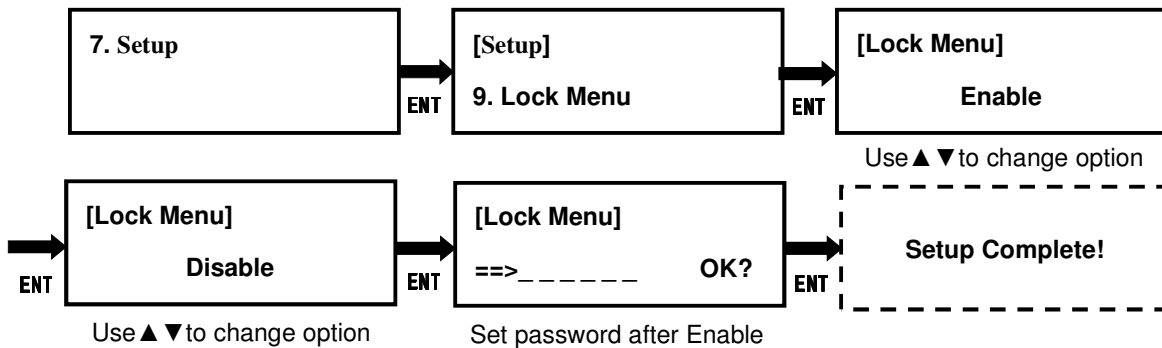

7.10 Language

This function allows to choose the language for display, and options are **English, Spanish, Portuguese, and Japanese**. English is the default language.

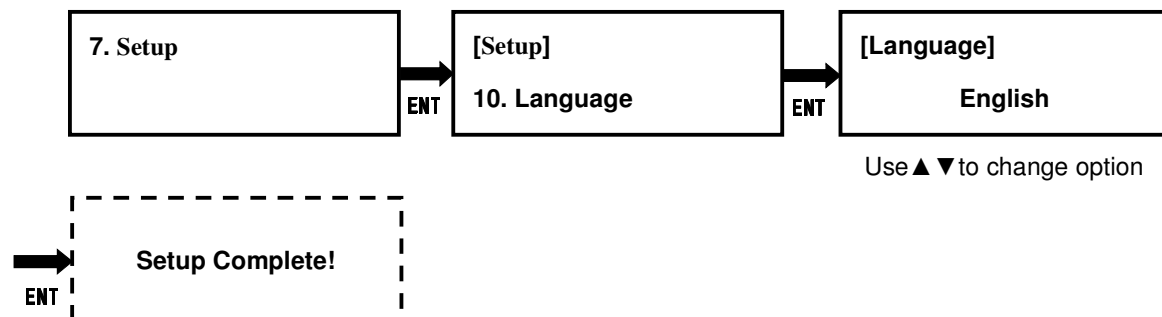

7.11 Clear Setup

This function resets the duplicator back to factory default settings.

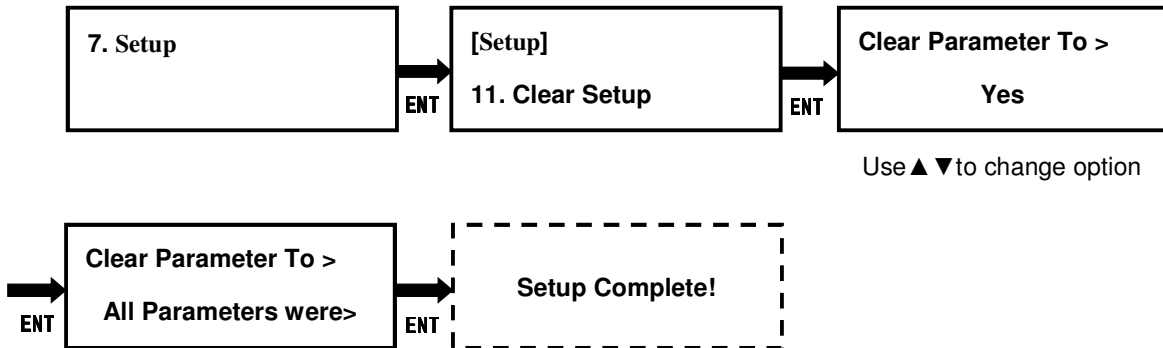

V. BASIC TROUBLESHOOTING

1. Duplicator copy speed depends on the SD/Micro SD card own read and write speed. Please change the SD/Micro SD card if the copy speed is very low and unacceptable.
2. This duplicator device cannot copy any data content with copy protection. For non-standard SD/Micro SD devices, please select Whole Media from Copy Area setup for duplication.
3. It is recommended to use the SD/Micro SD card with the same capacity for duplication, to avoid unexpected errors.
4. Customer must get pre-approved authorization from manufacturer in order to open the unit for repair or maintenance. Otherwise the warranty of the unit will be voided.
5. Customer must contact manufacturer to obtain proper firmware file for system update if it is necessary and provide with 6.5 System Info. Please follow the instructions when update firmware, and delete the firmware file after the update is done. Without the consent of the manufacturer of any behavior in spreading the firmware file is considered violation of copyright law, and the company will retain the legal recourse liability.